

S5N

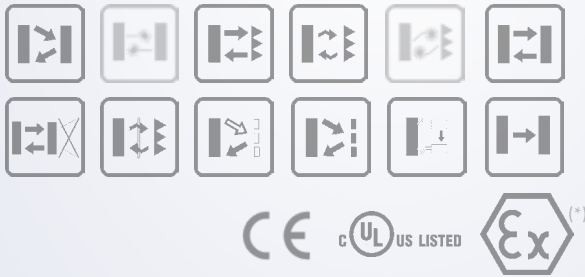

EXTENDED RANGE OF STANDARD “ONE FOR ALL” PHOTOELECTRIC TUBULAR M18 SENSORS

- All optic functions
- Improved EMI immunity
- Improved ambient light immunity
- Improved laser safety level
- M18 flat plastic with universal mounting
- Available in M18 metal housing
- Axial or radial optics, cable or connector
- Standard 4-wire NO-NC NPN or PNP output



APPLICATIONS

- Processing and Packaging machinery
- Conveyor lines, material handling
- Ceramics intralogistics
- Automated warehousing

S5N

Through beam		0...20 m
		0...60 m (class 1 LASER)
Retroreflective (on R2 reflector)		0,1...4 m
Polarized retroreflective		0,1...4 m
		0,1...16 m (class 1 LASER)
Retroreflective for transparent (on R2 reflector)		0,1...1,3 m
		short distance 0...100 mm
Diffuse proximity		medium distance 0...400 mm
		long distance 0...700 mm
		long distance LASER 0...350 mm
Fixed focus		100 mm
Background suppression		50...150 mm
Through beam with fiber optic		0...100 mm
Diffuse proximity with fiber optic		0...30 mm
Contrast sensor		10 ±2 mm
Luminescence sensor		0...20 mm
Power supply	Vdc	10...30 V
	Vac	
	Vac/dc	
Output	PNP	•
	NPN	•
	NPN/PNP	
	relay	
	other	IO-Link v 1.1
Connection	cable	•
	connector	•
	pig-tail	
Approximate dimensions (mm)		M18x 55/68
Housing material		PBT, nickel plated brass
Mechanical protection		IP67

TECHNICAL DATA

Power supply	10 ... 30 Vdc (limit values)
Ripple	2 Vpp max.
Consumption (output current excluded)	35 mA max. (mod. S5N...A00/B01/C01/C10/C21/D00/E01/T01)
	30 mA max. (mod. S5N...F01/M03)
	25 mA max. (mod. S5N...W03/U03)
Light emission	red LED 630 nm (mod. S5N...D00/E01, S5N-PA/MA...M03)
	red LED 660 nm (mod. S5N...B01/T01)
	red LED 670 nm (mod. S5N-PS/MS...M03)
	IR LED 880 nm (mod. S5N...A00/C01/C10/C20/C21/G00)
	white LED 400-700 nm (mod. S5N...W03)
	UV LED 370 nm (mod. S5N...U03)
	red Laser 650 nm (mod. S5N...G00/F01/B01/C01)
Setting	sensitivity trimmer (mod. B01/C01/C21/E01/F01/T01)
	teach-in push-button (mod. M03/W03/U03)
Operating mode	LIGHT mode on N.O. output / DARK mode on N.C. output (mod.S5N...C01/C10/C21/D00/M03/U03)
	DARK mode on N.O. output / LIGHT mode on N.C. output (mod.S5N...A00/B01/E01/F01/T01/W03)
Indicators	yellow OUTPUT LED (S5N, excl. mod. G00)
	green STABILITY LED (mod. S5N...B01/C01/C21/E01/F01), POWER LED (mod. S5N...G00)
	green/red READY/ERROR LED (mod. S5N...M03/W03/U03)
Output	PNP or NPN; NO; NC (mod. S5N) IO-Link v 1.1 (mod.S5N...OZ)
IO-Link interface	(mod.S5N...OZ) v 1.1, com 2, 38,4 kBaud, 32 bit process data, 5 ms cycle time LED emission model, 8 ms cycle time LASER emission model
Output current	100 mA max.
Saturation voltage	2 V max.
Response time	0,5 ms (mod. S5N...A00/B01/T01/C10/C21/C01/D00/E01/U03)
	2 ms (mod. S5N...F01/G00)
	1 ms (mod. S5N...M03)
	100 µs (mod. S5N...W03)
	333 µs (Laser mod. S5N)
Switching frequency	1 kHz (mod. S5N...A00/B01/T01/C10/C21/C01/D00/E01/U03)
	250 Hz (mod. S5N...F01/G00)
	500 Hz (mod. S5N...M03)
	5 kHz (mod. S5N...W03)
	1,5 kHz (Laser mod. S5N)
Connection	2 m cable Ø- 4 mm, M12 4-pole connector
Dielectric strength	500 Vac, 1 min between electronics and housing
Insulating resistance	>20 MΩ, 500 Vdc between electronics and housing
Electrical protection	class 2
Mechanical protection	IP67
Ambient light rejection	according to EN 60947-5-2
Vibrations	0,5 mm amplitude, 10 ... 55 Hz frequency, for every axis (EN60068-2-6)
Shock resistance	11 ms (30 G) 6 shock for every axis (EN60068-2-27)
Housing material	Plastic version PBT
	Metal version nickel plated brass
Lens material	PMMA
Operating temperature	-25 ... 55 °C
	(Laser mod.) -10 ... 50 °C
Storage temperature	-25 ... 70 °C
Weight	Plastic version 75 g max. cable vers. (90 g max. mod. M03), 25 g max. conn. vers. (40 g max. mod. M03)
	Metal version 110 g max. cable vers. (125 g max. mod. M03), 60 g max. conn. vers. (75 g max. mod. M03)

DIMENSION

PLASTIC

AXIAL VERSION

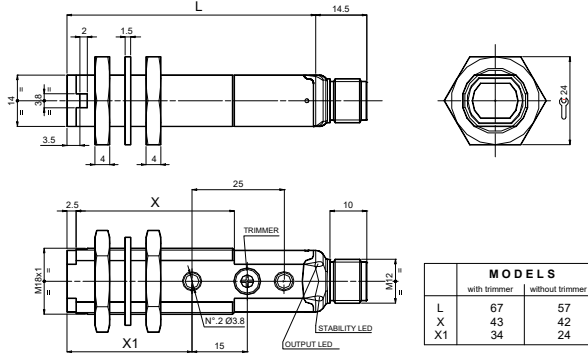

RADIAL VERSION

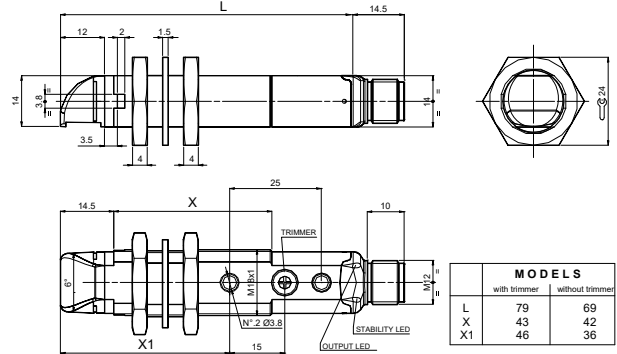

FIBRE OPTIC VERSION

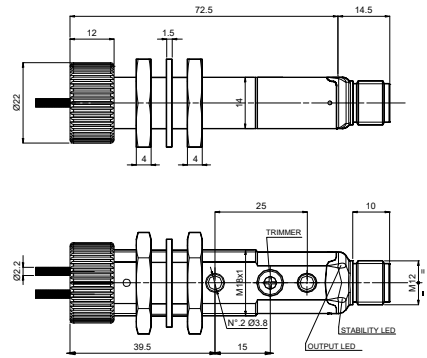

METAL

AXIAL VERSION

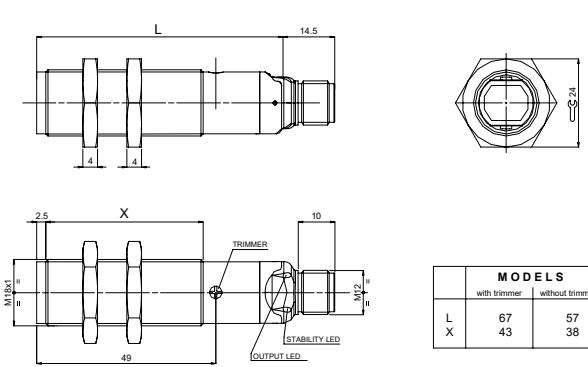

RADIAL VERSION

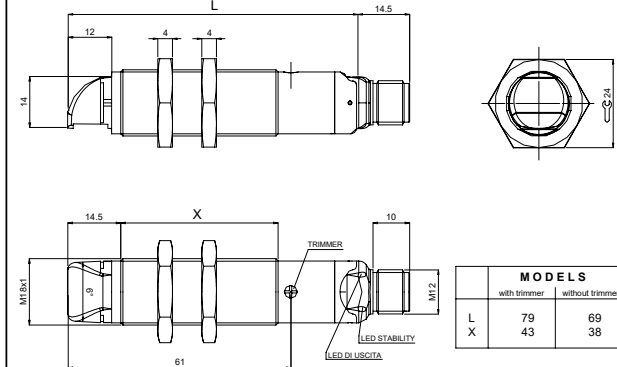

FIBRE OPTIC VERSION

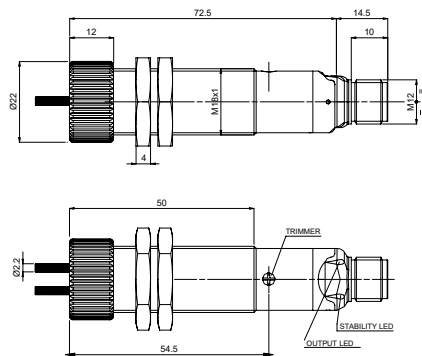

CONNECTIONS

CABLE

Through beam emitter

BROWN 1 + 10 ... 30 Vdc

WHITE 2 N.C. OUTPUT

BLACK 4 N.O. OUTPUT

BLUE 3 - 0 V

BROWN 1 + 10 ... 30 Vdc

WHITE 2 TEST +

BLACK 4 TEST / NOT USED (Laser version)

BLUE 3 - 0 V

M12 CONNECTOR

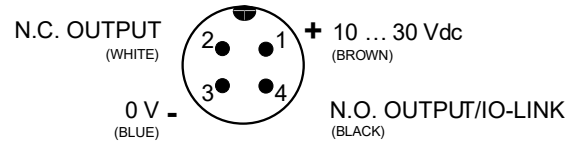
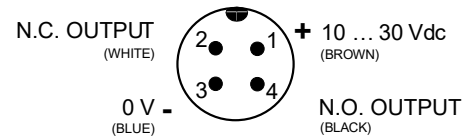

INDICATORS AND SETTINGS

S5N-XX...A00/B01/C01/C21/E01/F01/T01



- A** OUTPUT status LED Yellow
STABILITY LED Green (Only Receiver)
POWER ON LED Green (Only Emitter)

- B** Adjustment trimmer (receiver)

Single-turn trimmer for sensitivity adjustment. Rotate in a clockwise direction to increase the operating distance.

S5N-XX-M03/W03/U03

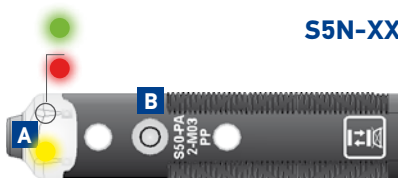

- A** OUTPUT status LED Yellow
READY LED Green

- B** Teach-in push-button

Teach-in button for setting. EASYtouch™ provides two setting modes: standard or fine, both obtained by pressing the push-button only once. Please refer to instructions manual for operating details.

S5N-XX-C10



- A00/C10/C20/F00
A OUTPUT status LED Yellow
Stability LED green

G00
OUTPUT status LED yellow (Only Emitter G00)

S5N DETECTION DIAGRAMS

G/F INFRARED EMISSION

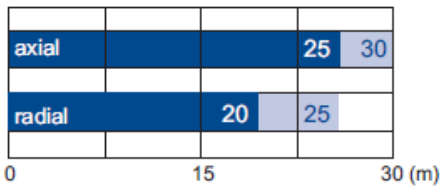

Recommended operating distance
Maximum operating distance

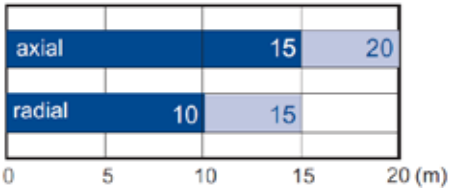
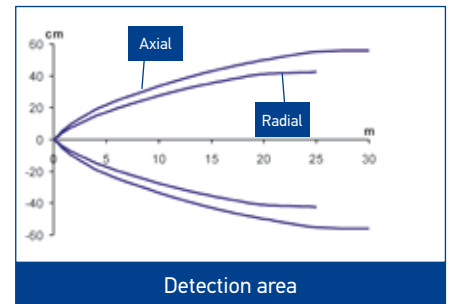
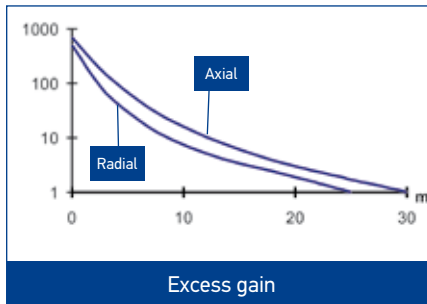

Recommended operating distance
Maximum operating distance

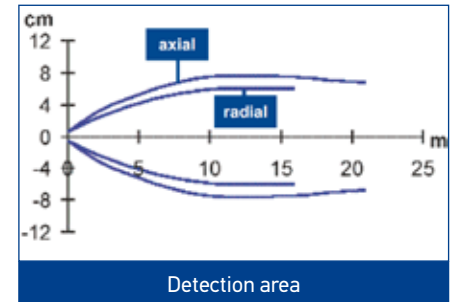
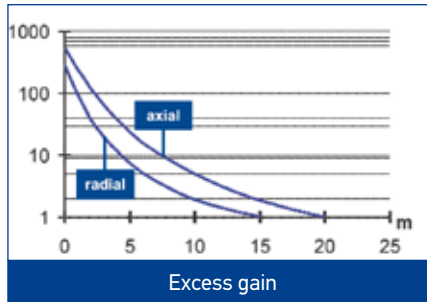

G/F LASER RED EMISSION

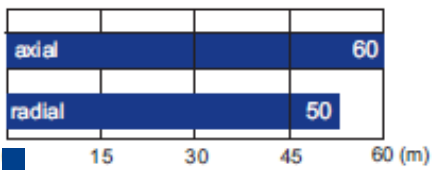

Operating distance

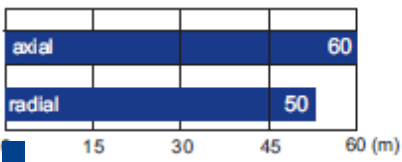
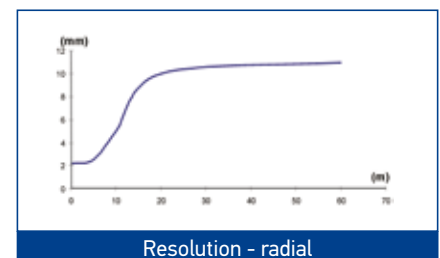
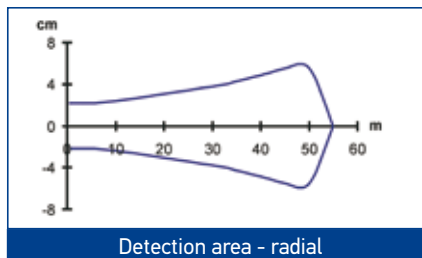
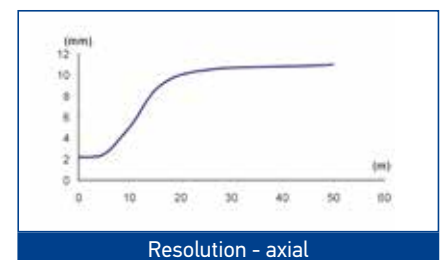
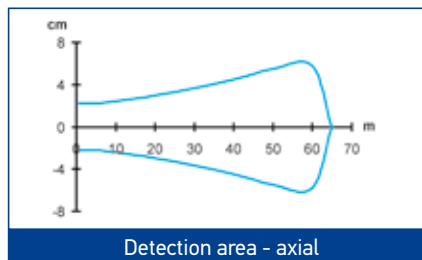

Operating distance

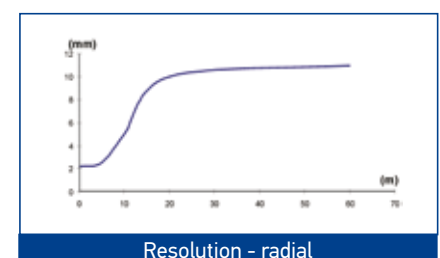
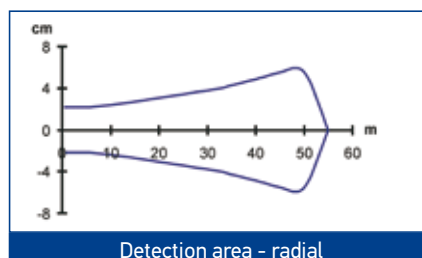
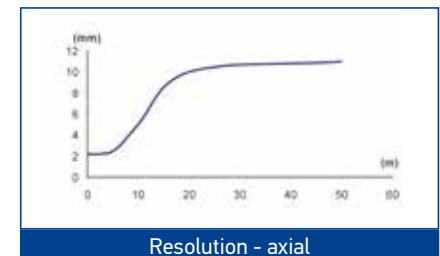
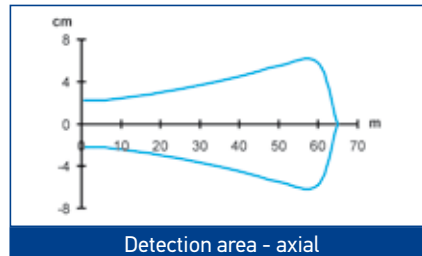

A INFRARED EMISSION

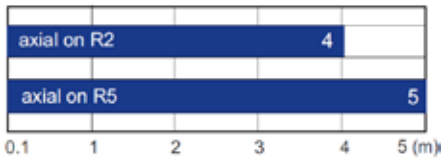

Operating distance

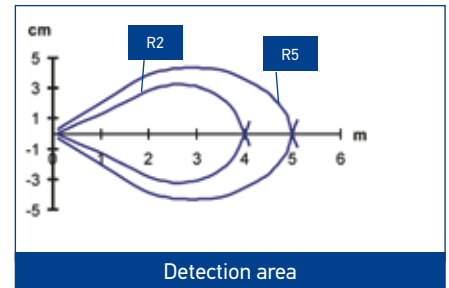
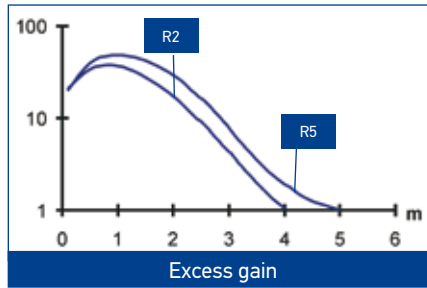

B RED EMISSION

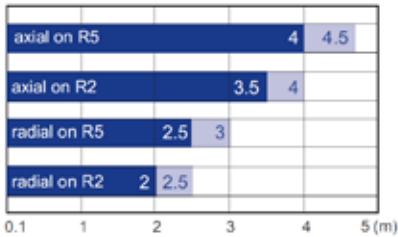

Recommended operating distance

Maximum operating distance

High efficiency reflectors can be used to obtain larger operating distances. Refer to **Reflectors** (A.01).

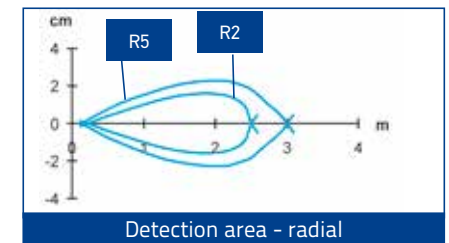
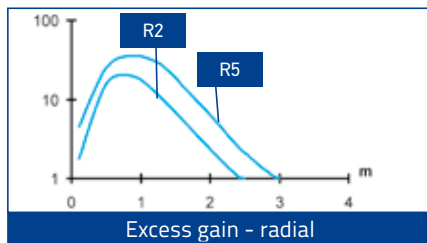
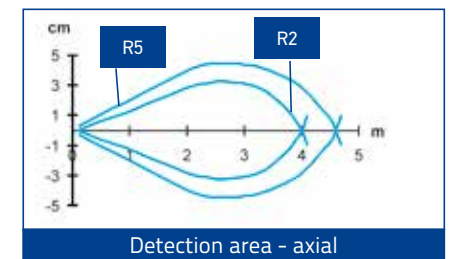
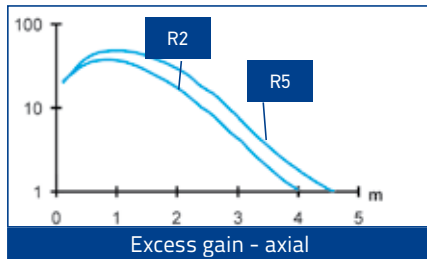

B LASER RED EMISSION

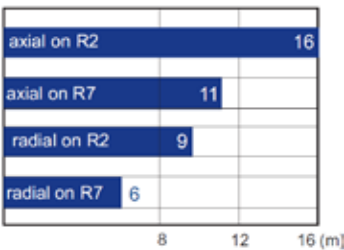

Operating distance

High efficiency reflectors can be used to obtain larger operating distances. Refer to **Reflectors** (A.01).

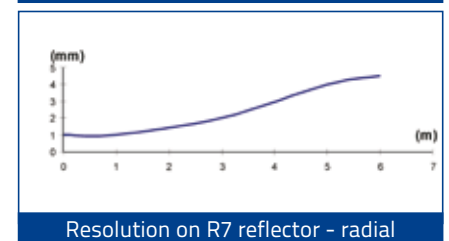
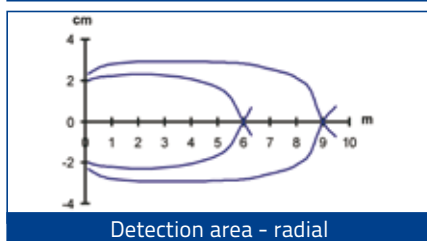
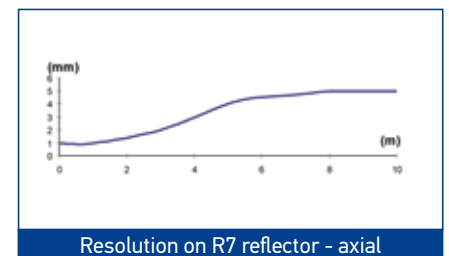
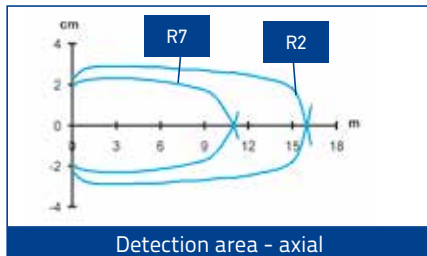

T RED EMISSION

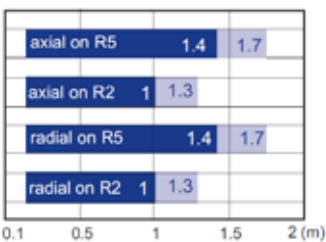

Recommended operating distance

Maximum operating distance

High efficiency reflectors can be used to obtain larger operating distances. Refer to **Reflectors**.

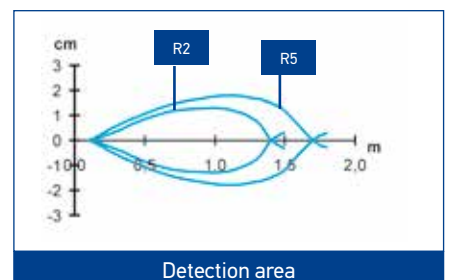
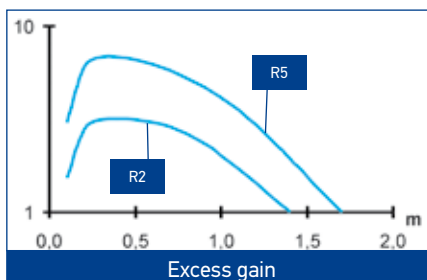

C SHORT INFRARED EMISSION

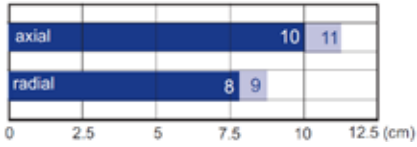

■ Recommended operating distance
 ■ Maximum operating distance

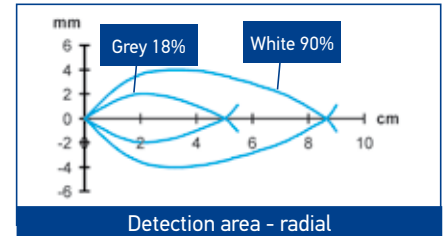
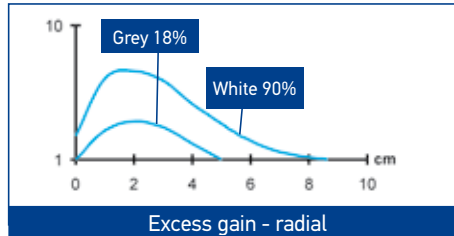
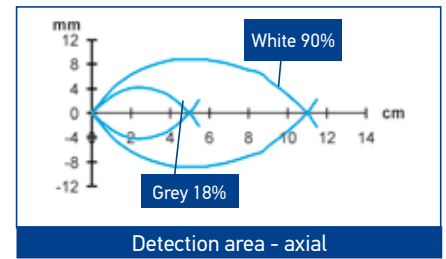
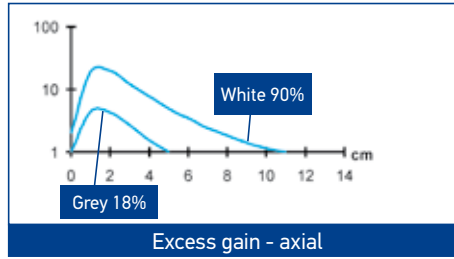

C MID INFRARED EMISSION

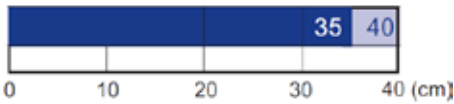

■ Recommended operating distance
 ■ Maximum operating distance

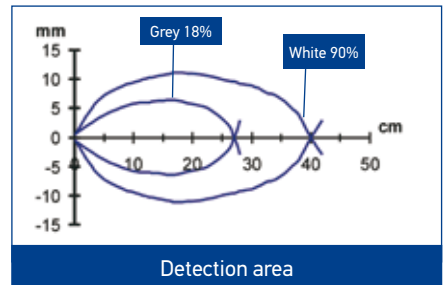
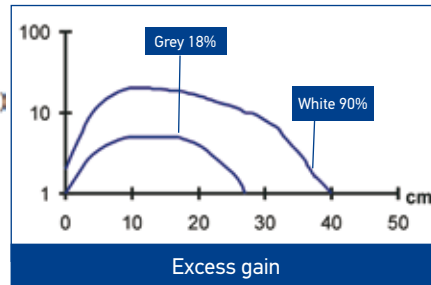

C LONG INFRARED EMISSION

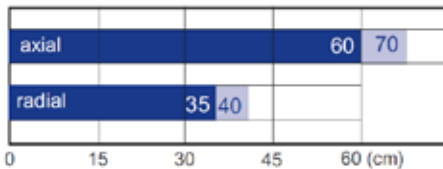

■ Recommended operating distance
 ■ Maximum operating distance

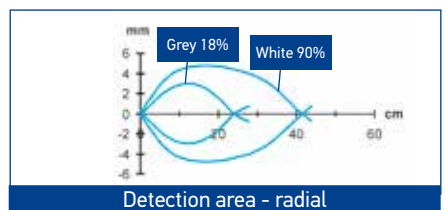
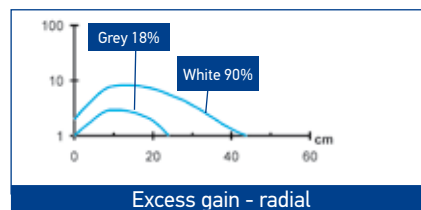
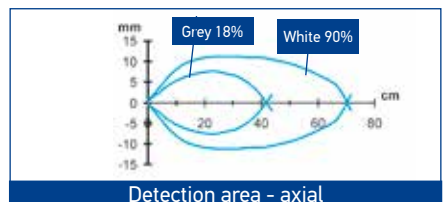
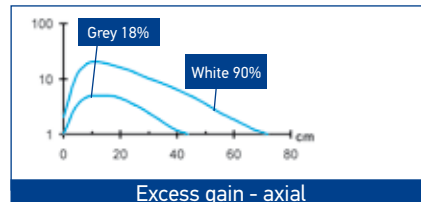

D RED EMISSION

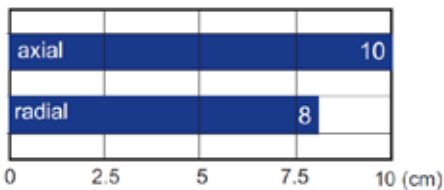

■ Operating distance

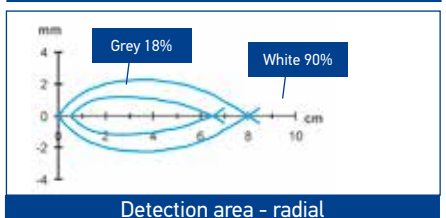
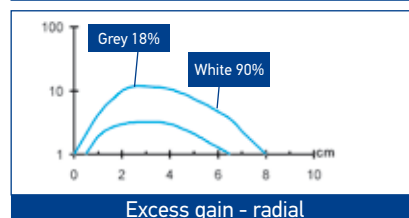
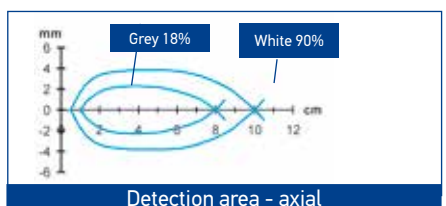
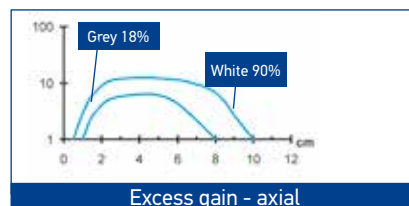

C LONG INFRARED EMISSION

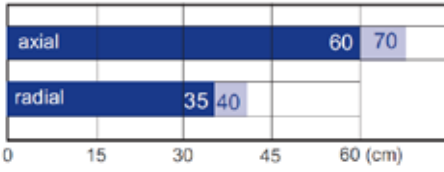

Recommended operating distance
 Maximum operating distance

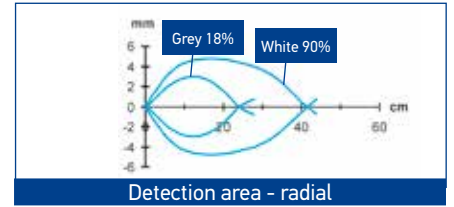
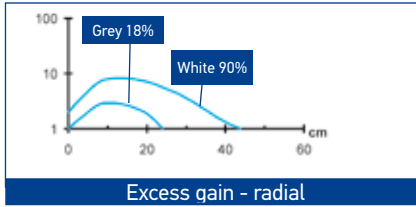
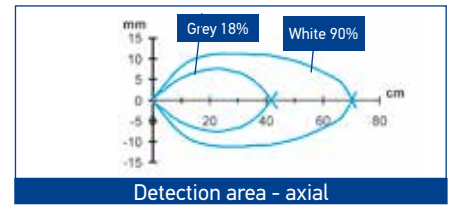
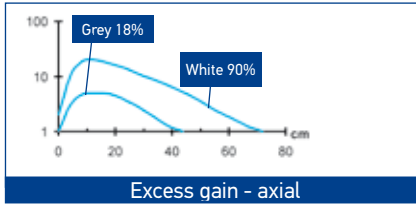

D RED EMISSION

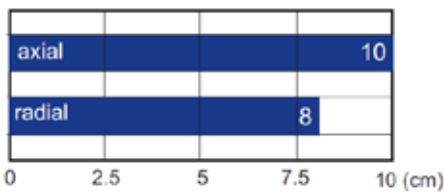

Operating distance

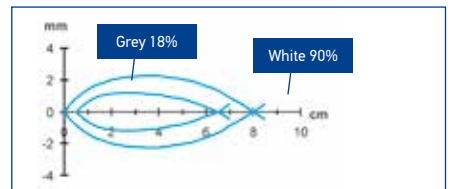
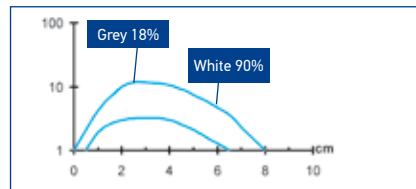
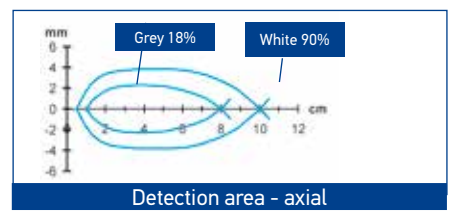
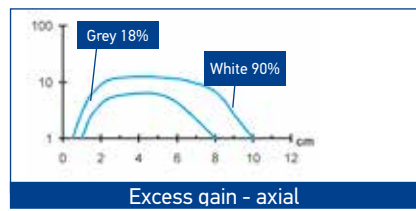

C LASER RED EMISSION

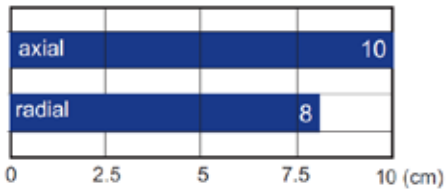

Operating distance

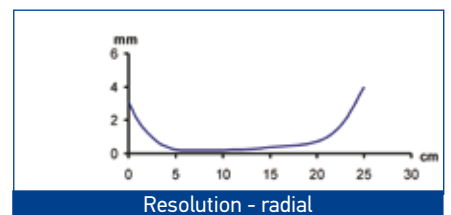
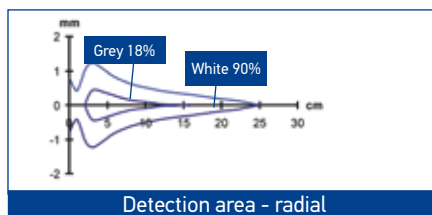
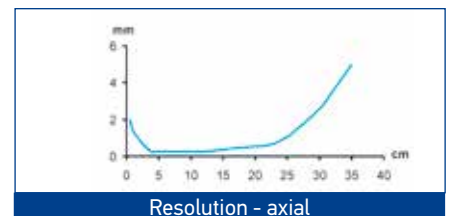
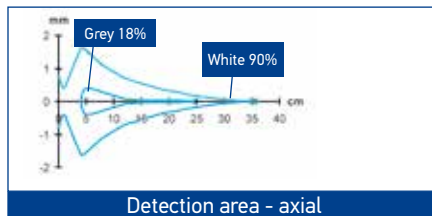

M AXIAL RED EMISSION

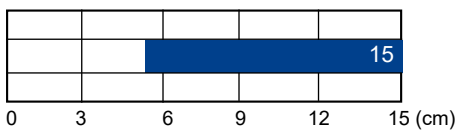

Operating distance

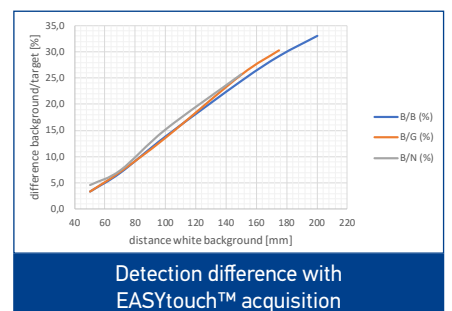
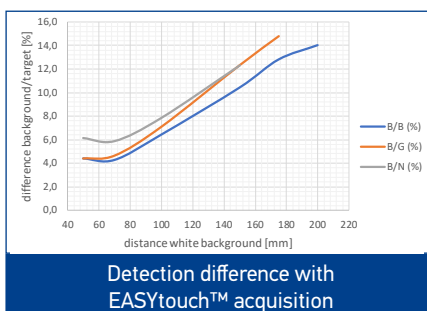

M RADIAL RED EMISSION

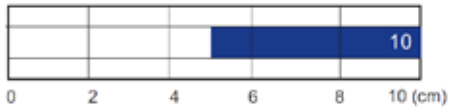

Operating distance

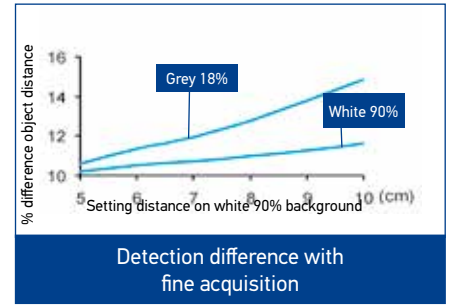
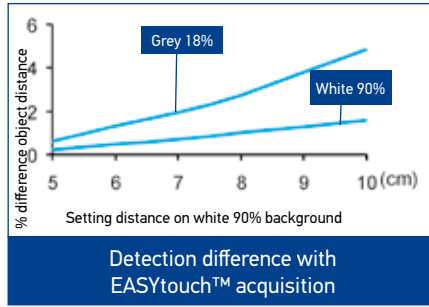

E RED EMISSION

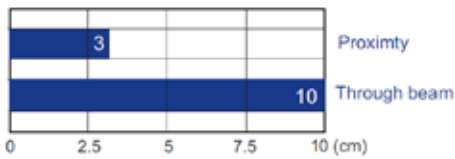

Operating distance with standard fibers

Standard Fiber-optics:
OF-42-ST-20 proximity
OF-43-ST-20 through beam

High efficiency fiber-optics or accessory lenses can be used to obtain larger operating distances.

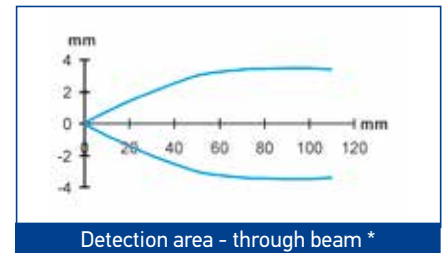
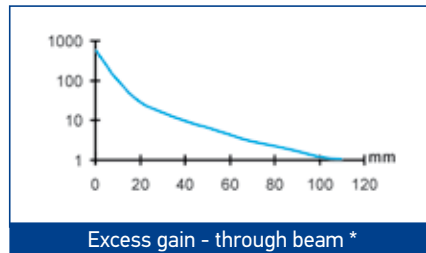
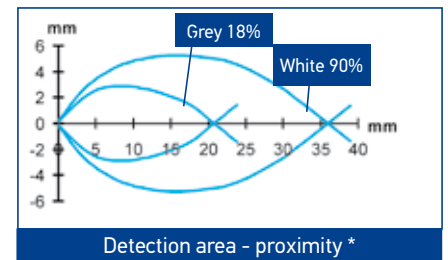
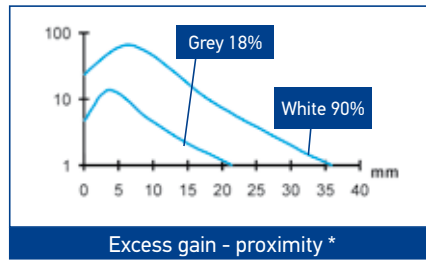

* standard Fiber-optics

W WHITE EMISSION

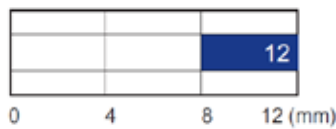

Operating distance

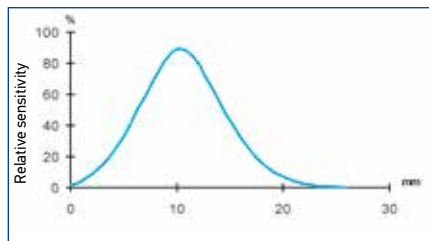

U UV EMISSION

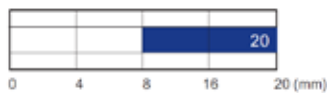

Operating distance

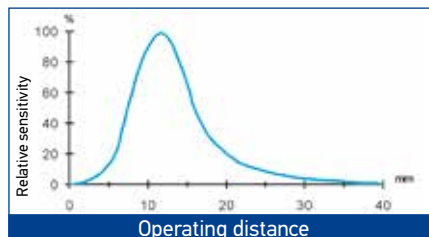

MODEL SELECTION AND ORDER INFORMATION

S5N PLASTIC MODELS					
OPTIC FUNCTION	EMISSION	CONNECTION	OUTPUT	MODEL	ORDER No.
Retroreflective	LED, Axial optic	2m Cable	NPN	S5N-PA-2-A00-NN	952002091
			PNP	S5N-PA-2-A00-PP	952002081
		M12 Connector	NPN	S5N-PA-5-A00-NN	952002111
			PNP	S5N-PA-5-A00-PP	952002101
Polarized retroreflective	LED, Axial optic	2m Cable	NPN	S5N-PA-2-B01-NN	952001611
			PNP	S5N-PA-2-B01-PP	952001011
		M12 Connector	NPN	S5N-PA-5-B01-NN	952001501
			PNP	S5N-PA-5-B01-PP	952001021
			IO-Link	S5N-PA-5-B01-OZ	952002200
	LED, Radial optic	2m Cable	NPN	S5N-PR-2-B01-NN	952001781
			PNP	S5N-PR-2-B01-PP	952001031
		M12 Connector	NPN	S5N-PR-5-B01-NN	952001721
			PNP	S5N-PR-5-B01-PP	952001041
	LASER, Axial optic	2m Cable	NPN	S5N-PL-2-B01-NN	952001871
			PNP	S5N-PL-2-B01-PP	952001361
			IO-Link	S5N-PL-2-B01-OZ	952002250
		M12 Connector	NPN	S5N-PL-5-B01-NN	952001841
			PNP	S5N-PL-5-B01-PP	952001371
			IO-Link	S5N-PL-5-B01-OZ	952002250
	LASER, Radial optic	2m Cable	NPN	S5N-PH-2-B01-NN	952001951
			PNP	S5N-PH-2-B01-PP	952001941
			IO-Link	S5N-PH-2-B01-OZ	952002250
		M12 Connector	NPN	S5N-PH-5-B01-NN	952001971
PNP			S5N-PH-5-B01-PP	952001961	
IO-Link			S5N-PH-5-B01-OZ	952002250	
Long Diffuse proximity	LED, Axial optic	2m Cable	NPN	S5N-PA-2-C01-NN	952001621
			PNP	S5N-PA-2-C01-PP	952001051
		M12 Connector	NPN	S5N-PA-5-C01-NN	952001511
			PNP	S5N-PA-5-C01-PP	952001061
			IO-Link	S5N-PA-5-C01-OZ	952002210
	LED, Radial optic	2m Cable	NPN	S5N-PR-2-C01-NN	952001791
			PNP	S5N-PR-2-C01-PP	952001071
		M12 Connector	NPN	S5N-PR-5-C01-NN	952001731
			PNP	S5N-PR-5-C01-PP	952001081
			IO-Link	S5N-PR-5-C01-OZ	952002260
	LASER, Axial optic	2m Cable	NPN	S5N-PL-2-C01-NN	952001881
			PNP	S5N-PL-2-C01-PP	952001381
			IO-Link	S5N-PL-2-C01-OZ	952002260
		M12 Connector	NPN	S5N-PL-5-C01-NN	952001851
			PNP	S5N-PL-5-C01-PP	952001391
			IO-Link	S5N-PL-5-C01-OZ	952002260
	LASER, Radial optic	2m Cable	NPN	S5N-PH-2-C01-NN	952001991
			PNP	S5N-PH-2-C01-PP	952001981
IO-Link			S5N-PH-2-C01-OZ	952002260	
M12 Connector		NPN	S5N-PH-5-C01-NN	952002011	
		PNP	S5N-PH-5-C01-PP	952002001	
		IO-Link	S5N-PH-5-C01-OZ	952002260	
Short Diffuse proximity	LED, Axial optic	2m Cable	NPN	S5N-PA-2-C10-NN	952001631
			PNP	S5N-PA-2-C10-PP	952001241
		M12 Connector	NPN	S5N-PA-5-C10-NN	952001521
			PNP	S5N-PA-5-C10-PP	952001251
	LED, Radial optic	2m Cable	NPN	S5N-PR-2-C10-NN	952001801
			PNP	S5N-PR-2-C10-PP	952001491
		M12 Connector	NPN	S5N-PR-5-C10-NN	952001741
			PNP	S5N-PR-5-C10-PP	952001481
Medium Diffuse proximity	LED, Axial optic	2m Cable	NPN	S5N-PA-2-C21-NN	952002171
			PNP	S5N-PA-2-C21-PP	952002161
		M12 Connector	NPN	S5N-PA-5-C21-NN	952002191
			PNP	S5N-PA-5-C21-PP	952002181

Fixed focus	LED, Axial optic	2m Cable	NPN	S5N-PA-2-D00-NN	952001641		
			PNP	S5N-PA-2-D00-PP	952001091		
		M12 Connector	NPN	S5N-PA-5-D00-NN	952001531		
	PNP		S5N-PA-5-D00-PP	952001101			
	LED, Radial optic	2m Cable	NPN	S5N-PR-2-D00-NN	952001811		
			PNP	S5N-PR-2-D00-PP	952001111		
M12 Connector		NPN	S5N-PR-5-D00-NN	952001751			
	PNP	S5N-PR-5-D00-PP	952001121				
Fiber optic	LED, Axial optic	2m Cable	NPN	S5N-PA-2-E01-NN	952001651		
			PNP	S5N-PA-2-E01-PP	952001131		
		M12 Connector	NPN	S5N-PA-5-E01-NN	952001541		
			PNP	S5N-PA-5-E01-PP	952001141		
Through beam receiver	LED, Axial optic	2m Cable	NPN	S5N-PA-2-F01-NN	952001661		
			PNP	S5N-PA-2-F01-PP	952001151		
		M12 Connector	NPN	S5N-PA-5-F01-NN	952001551		
			PNP	S5N-PA-5-F01-PP	952001161		
		LED, Radial optic	2m Cable	NPN	S5N-PR-2-F01-NN	952001821	
				PNP	S5N-PR-2-F01-PP	952001171	
	M12 Connector		NPN	S5N-PR-5-F01-NN	952001761		
			PNP	S5N-PR-5-F01-PP	952001181		
	LASER, Axial optic	2m Cable	NPN	S5N-PL-2-F01-NN	952001891		
			PNP	S5N-PL-2-F01-PP	952001401		
		M12 Connector	NPN	S5N-PL-5-F01-NN	952001861		
			PNP	S5N-PL-5-F01-PP	952001411		
	LASER, Radial optic	2m Cable	NPN	S5N-PH-2-F01-NN	952002031		
			PNP	S5N-PH-2-F01-PP	952002021		
		M12 Connector	NPN	S5N-PH-5-F01-NN	952002051		
			PNP	S5N-PH-5-F01-PP	952002041		
	Through beam emitter	LED, Axial optic	2m Cable	-	S5N-PA-2-G00-XG	952001191	
			M12 Connector	-	S5N-PA-5-G00-XG	952001201	
LED, Radial optic		2m Cable	-	S5N-PR-2-G00-XG	952001211		
		M12 Connector	-	S5N-PR-5-G00-XG	952001221		
LASER, Axial optic		2m Cable	-	S5N-PL-2-G00-XG	952001421		
		M12 Connector	-	S5N-PL-5-G00-XG	952001431		
LASER, Radial optic		2m Cable	-	S5N-PH-2-G00-XG	952002061		
		M12 Connector	-	S5N-PH-5-G00-XG	952002071		
Background suppression		LED, Axial optic	2m Cable	NPN	S5N-PA-2-M03-NN	952001671	
				PNP	S5N-PA-2-M03-PP	952001231	
	M12 Connector		NPN	S5N-PA-5-M03-NN	952001561		
			PNP	S5N-PA-5-M03-PP	952001001		
	LED, Radial optic	2m Cable	IO-Link	S5N-PA-5-M03-OZ	952002230		
			NPN	S5N-PS-2-M03-NN	952001901		
		M12 Connector	PNP	S5N-PS-2-M03-PP	952001911		
			NPN	S5N-PS-5-M03-NN	952001921		
			PNP	S5N-PS-5-M03-PP	952001931		
Retroreflective for transparent	LED, Axial optic	2m Cable	NPN	S5N-PA-2-T01-NN	952001691		
			PNP	S5N-PA-2-T01-PP	952001261		
		M12 Connector	NPN	S5N-PA-5-T01-NN	952001581		
			PNP	S5N-PA-5-T01-PP	952001271		
		LED, Radial optic	2m Cable	IO-Link	S5N-PA-5-T01-OZ	952002220	
				NPN	S5N-PR-2-T01-NN	952001831	
	M12 Connector		PNP	S5N-PR-2-T01-PP	952001281		
			NPN	S5N-PR-5-T01-NN	952001771		
				PNP	S5N-PR-5-T01-PP	952001291	
	Luminescence	LED, Axial optic	2m Cable	NPN	S5N-PA-2-U03-NN	952001701	
PNP				S5N-PA-2-U03-PP	952001301		
M12 Connector			NPN	S5N-PA-5-U03-NN	952001591		
			PNP	S5N-PA-5-U03-PP	952001311		
Contrast	LED, Axial optic	2m Cable	NPN	S5N-PA-2-W03-NN	952001711		
			PNP	S5N-PA-2-W03-PP	952001321		
		M12 Connector	NPN	S5N-PA-5-W03-NN	952001601		
			PNP	S5N-PA-5-W03-PP	952001331		
					IO-Link	S5N-PA-5-W03-OZ	952002240

S5N METAL MODELS

OPTIC FUNCTION	EMISSION	CONNECTION	OUTPUT	MODEL	ORDER No.
Retroreflective	LED, Axial optic	2m Cable	NPN	S5N-MA-2-A00-NN	952022091
			PNP	S5N-MA-2-A00-PP	952022081
		M12 Connector	NPN	S5N-MA-5-A00-NN	952022111
			PNP	S5N-MA-5-A00-PP	952022101
Polarized retroreflective	LED, Axial optic	2m Cable	NPN	S5N-MA-2-B01-NN	952021501
			PNP	S5N-MA-2-B01-PP	952021001
		M12 Connector	NPN	S5N-MA-5-B01-NN	952021661
			PNP	S5N-MA-5-B01-PP	952021201
			IO-Link	S5N-MA-5-B01-OZ	952022160
	LED, Radial optic	2m Cable	NPN	S5N-MR-2-B01-NN	952021601
			PNP	S5N-MR-2-B01-PP	952021141
		M12 Connector	NPN	S5N-MR-5-B01-NN	952021761
			PNP	S5N-MR-5-B01-PP	952021341
	LASER, Axial optic	2m Cable	NPN	S5N-ML-2-B01-NN	952021821
			PNP	S5N-ML-2-B01-PP	952021401
		M12 Connector	NPN	S5N-ML-5-B01-NN	952021851
			PNP	S5N-ML-5-B01-PP	952021441
			IO-Link	S5N-ML-5-B01-OZ	952022180
LASER, Radial optic	2m Cable	NPN	S5N-MH-2-B01-NN	952021951	
		PNP	S5N-MH-2-B01-PP	952021941	
	M12 Connector	NPN	S5N-MH-5-B01-NN	952021971	
		PNP	S5N-MH-5-B01-PP	952021961	
Long Diffuse proximity	LED, Axial optic	2m Cable	NPN	S5N-MA-2-C01-NN	952021511
			PNP	S5N-MA-2-C01-PP	952021011
		M12 Connector	NPN	S5N-MA-5-C01-NN	952021671
			PNP	S5N-MA-5-C01-PP	952021211
	LED, Radial optic	2m Cable	NPN	S5N-MR-2-C01-NN	952021611
			PNP	S5N-MR-2-C01-PP	952021151
		M12 Connector	NPN	S5N-MR-5-C01-NN	952021771
			PNP	S5N-MR-5-C01-PP	952021351
	LASER, Axial optic	2m Cable	NPN	S5N-ML-2-C01-NN	952021831
			PNP	S5N-ML-2-C01-PP	952021411
		M12 Connector	NPN	S5N-ML-5-C01-NN	952021861
			PNP	S5N-ML-5-C01-PP	952021451
			IO-Link	S5N-ML-5-C01-OZ	952022190
	LASER, Radial optic	2m Cable	NPN	S5N-MH-2-C01-NN	952021991
			PNP	S5N-MH-2-C01-PP	952021981
M12 Connector		NPN	S5N-MH-5-C01-NN	952022011	
		PNP	S5N-MH-5-C01-PP	952022001	
Short Diffuse proximity	LED, Axial optic	2m Cable	NPN	S5N-MA-2-C10-NN	952021521
			PNP	S5N-MA-2-C10-PP	952021021
		M12 Connector	NPN	S5N-MA-5-C10-NN	952021681
			PNP	S5N-MA-5-C10-PP	952021221
	LED, Radial optic	2m Cable	NPN	S5N-MR-2-C10-NN	952021621
			PNP	S5N-MR-2-C10-PP	952021491
		M12 Connector	NPN	S5N-MR-5-C10-NN	952021781
			PNP	S5N-MR-5-C10-PP	952021481
Medium Diffuse proximity	LED, Axial optic	2m Cable	NPN	S5N-MA-2-C21-NN	952022131
			PNP	S5N-MA-2-C21-PP	952022121
		M12 Connector	NPN	S5N-MA-5-C21-NN	952022151
			PNP	S5N-MA-5-C21-PP	952022141

Fixed focus	LED, Axial optic	2m Cable	NPN	S5N-MA-2-D00-NN	952021531
			PNP	S5N-MA-2-D00-PP	952021031
	M12 Connector		NPN	S5N-MA-5-D00-NN	952021691
			PNP	S5N-MA-5-D00-PP	952021231
	LED, Radial optic	2m Cable	NPN	S5N-MR-2-D00-NN	952021631
			PNP	S5N-MR-2-D00-PP	952021161
M12 Connector		NPN	S5N-MR-5-D00-NN	952021791	
		PNP	S5N-MR-5-D00-PP	952021361	
Fiber optic	LED, Axial optic	2m Cable	NPN	S5N-MA-2-E01-NN	952021881
			PNP	S5N-MA-2-E01-PP	952021041
	M12 Connector		NPN	S5N-MA-5-E01-NN	952021891
			PNP	S5N-MA-5-E01-PP	952021241
Through beam receiver	LED, Axial optic	2m Cable	NPN	S5N-MA-2-F01-NN	952021541
			PNP	S5N-MA-2-F01-PP	952021051
	M12 Connector		NPN	S5N-MA-5-F01-NN	952021701
			PNP	S5N-MA-5-F01-PP	952021251
	LED, Radial optic	2m Cable	NPN	S5N-MR-2-F01-NN	952021641
			PNP	S5N-MR-2-F01-PP	952021171
	M12 Connector		NPN	S5N-MR-5-F01-NN	952021801
			PNP	S5N-MR-5-F01-PP	952021371
	LASER, Axial optic	2m Cable	NPN	S5N-ML-2-F01-NN	952021841
			PNP	S5N-ML-2-F01-PP	952021421
	M12 Connector		NPN	S5N-ML-5-F01-NN	952021871
			PNP	S5N-ML-5-F01-PP	952021461
LASER, Radial optic	2m Cable	NPN	S5N-MH-2-F01-NN	952022031	
		PNP	S5N-MH-2-F01-PP	952022021	
M12 Connector		NPN	S5N-MH-5-F01-NN	952022051	
		PNP	S5N-MH-5-F01-PP	952022041	
Through beam emitter	LED, Axial optic	2m Cable	-	S5N-MA-2-G00-XG	952021061
		M12 Connector	-	S5N-MA-5-G00-XG	952021261
	LED, Radial optic	2m Cable	-	S5N-MR-2-G00-XG	952021181
		M12 Connector	-	S5N-MR-5-G00-XG	952021381
	LASER, Axial optic	2m Cable	-	S5N-ML-2-G00-XG	952021431
		M12 Connector	-	S5N-ML-5-G00-XG	952021471
LASER, Radial optic	2m Cable	-	S5N-MH-2-G00-XG	952022061	
	M12 Connector	-	S5N-MH-5-G00-XG	952022071	
Background suppression	LED, Axial optic	2m Cable	NPN	S5N-MA-2-M03-NN	952021551
			PNP	S5N-MA-2-M03-PP	952021071
	M12 Connector		PNP	S5N-MA-5-M03-PP	952021271
			IO-Link	S5N-MA-5-M03-OZ	952022170
LED, Radial optic	2m Cable	PNP	S5N-MS-2-M03-PP	952021911	
	M12 Connector	PNP	S5N-MS-5-M03-PP	952021931	
Retroreflective for transparent	LED, Axial optic	2m Cable	NPN	S5N-MA-2-T01-NN	952021571
			PNP	S5N-MA-2-T01-PP	952021091
	M12 Connector		NPN	S5N-MA-5-T01-NN	952021731
			PNP	S5N-MA-5-T01-PP	952021291
	LED, Radial optic	2m Cable	NPN	S5N-MR-2-T01-NN	952021651
			PNP	S5N-MR-2-T01-PP	952021191
M12 Connector		NPN	S5N-MR-5-T01-NN	952021811	
		PNP	S5N-MR-5-T01-PP	952021391	
Luminescence	LED, Axial optic	M12 Connector	PNP	S5N-MA-5-U03-PP	952021301
Contrast	LED, Axial optic	2m Cable	PNP	S5N-MA-2-W03-PP	952021111
		M12 Connector	NPN	S5N-MA-5-W03-NN	952021751
	PNP		S5N-MA-5-W03-PP	952021311	

ACCESSORIES

ST-5010

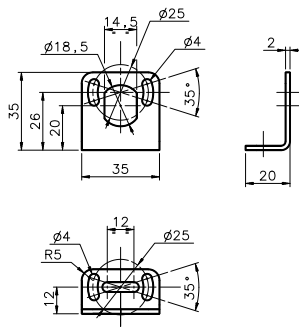

ST-5011

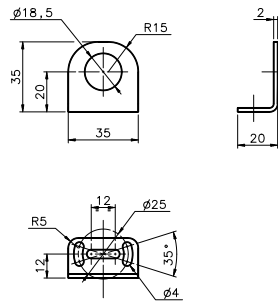

ST-5012

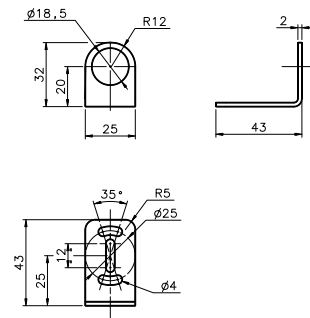

ST-5017

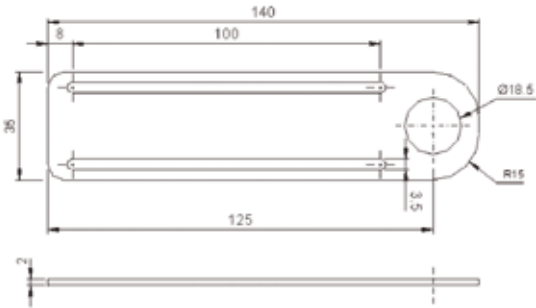

SWING-18

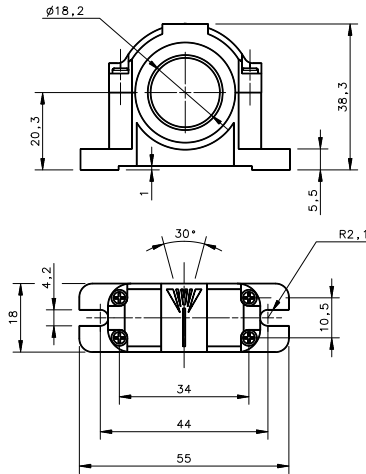

PLASTIC NUT

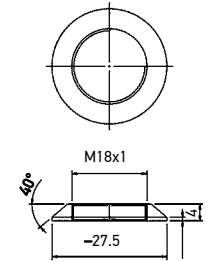

SP-40

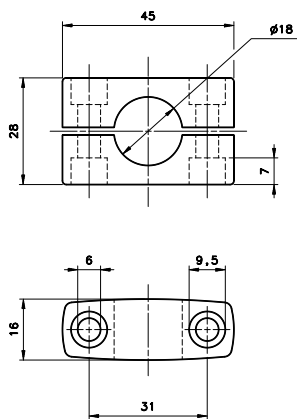

JOINT 18

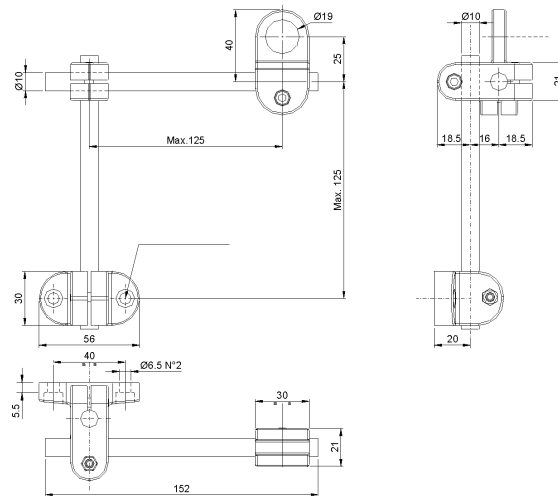

MICRO 18

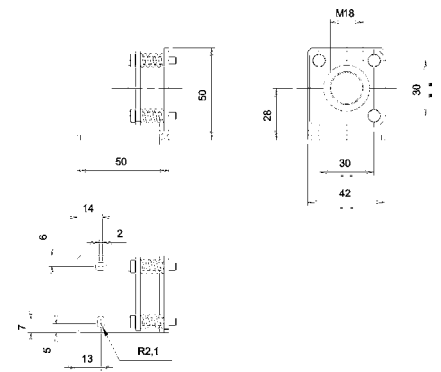

mm

MODEL	DESCRIPTION	ORDER No.
ST-5010	M18/14 mounting bracket	95ACC5230
ST-5011	M18 mounting bracket short	95ACC5240
ST-5012	M18 mounting bracket long	95ACC5250
ST-5017	M18 mounting bracket	95ACC5270
S50 EASY -IN	M18/14 EASY in™ adjustable mounting support	95ACC 5300
JOINT -18	M18 jointed support	95ACC 5220
MICRO -18	support with micrometric regulation for tubular M18 sensors	95ACC 1380
ST1218	M12/M18 mounting brackets	95ACC3340
ST1830	M18/M30 mounting brackets	95ACC3350
SP-40	mounting bracket tubular	95ACC1370
SWING-18	adjustable support for M18 tubular sensors	895000006
PLASTIC NUT	flared mounting nut	95ACC2630
MEK -PROOF	front protection (only for metal models)	G5000001

IO-LINK CONNECTIVITY

MODEL	DESCRIPTION	ORDER No.
CBX-8IOL-EIP	CBX-8IOL-EIP 8P IOL M12 EIP MASTER	95ACC8180
CBX-8IOL-PNIO	CBX-8IOL-PNIO 8P IOL M12 PROFINET MASTER	95ACC8190

CABLES

TYPE	DESCRIPTION	LENGTH	MODEL	ORDER No.
Axial M12 Connector	4-pole, grey, P.V.C.	3 m	CS-A1-02-G-03	95A251380
		5 m	CS-A1-02-G-05	95A251270
		7 m	CS-A1-02-G-07	95A251280
		10 m	CS-A1-02-G-10	95A251390
Radial M12 Connector	4-pole, grey, P.V.C.	2 m	CS-A1-02-R-02	95A251540
		5 m	CS-A1-02-R-05	95A251560
		10 m	CS-A1-02-R-10	95A251570
Radial M12 Connector	4-pole, P.U.R.	3 m	CS-A2-02-G-03	95A251360
		5 m	CS-A2-02-G-05	95A251240
		7 m	CS-A2-02-G-07	95A251245
		10 m	CS-A2-02-G-10	95A251260
Radial M12 Connector with LED (for PNP N.O. sensors)	4-pole, grey, P.V.C.	2 m	CS-A2-02-R-02	95A251550
		5 m	CS-A2-02-R-05	95A251570
		10 m	CS-A2-02-R-10	95A251580
Axial M12 Connector	4-pole, shielded, black, P.V.C.	3 m	CS-A2-12-G-03	95A251400
		5 m	CS-A2-12-G-05	95A251350
		10 m	CS-A2-12-G-10	95A251370
		15 m	CS-A2-12-G-15	95A251380
Radial M12 Connector	4-pole, shielded, black, P.V.C.	3 m	CV-A1-22-B-03	95ACC1480
		5 m	CV-A1-22-B-05	95ACC1490
		10 m	CV-A1-22-B-10	95ACC1500
		15 m	CV-A1-22-B-15	95ACC2070
		25 m	CV-A1-22-B-25	95ACC2090
Axial M12 Connector	4-pole, U.L., black, P.V.C.	3 m	CV-A2-22-B-03	95ACC1540
		5 m	CV-A2-22-B-05	95ACC1550
		10 m	CV-A2-22-B-10	95ACC1560
		15 m	CV-A2-22-B-15	95ACC1570
		25 m	CV-A2-22-B-25	95ACC1580
Radial M12 Connector	4-pole, black	3 m	CS-A1-02-U-03	95ASE1120
		5 m	CS-A1-02-U-05	95ASE1130
		10 m	CS-A1-02-U-10	95ASE1140
		15 m	CS-A1-02-U-15	95ASE1150
		25 m	CS-A1-02-U-25	95ASE1160
Axial M12 Connector	4-pole, black	Connector- not cabled	CS-A1-02-B-NC	G5085002
Radial M12 Connector	4-pole, black	Connector- not cabled	CS-A2-02-B-NC	G5085003
Axial M12 Connector	5-pole, L coded power cable	3 m	CS-M1-02-B-03	95ACC0007
Axial M12 F/M8 M Connector	4-pole, double headed	3 m	CS-H1-02-B-03	95ACC0008
Axial M12 F/M12 M Connector	4-pole, double headed	3 m	CS-I1-02-B-03	95ACC0009

DATALOGIC PRODUCT OFFERING



Sensors



Hand Held scanners



Mobile Computers



Laser Marking Systems



Safety Laser Scanner



Vision Systems



Stationary Industrial Scanners



Safety Light Curtains

Rev. 01, 04/2017