

# SMART Transmitter Power Supply

## KFD2-STC5-Ex1.20

- 1-channel isolated barrier
- 24 V DC supply (Power Rail)
- Input 2-wire and 3-wire SMART transmitters and 2-wire SMART current sources
- Signal splitter (1 input and 2 outputs)
- Dual output 0/4 mA ... 20 mA, current sink/current source
- Terminals with test points
- Up to SIL 3 acc. to IEC 61508



SIL 3



### Function

This isolated barrier is used for intrinsic safety applications. The device supplies 2-wire and 3-wire SMART transmitters, and can also be used with 2-wire SMART current sources. It transfers the analog input signal to the safe area as two isolated output signals. Digital signals may be superimposed on the input signal in the hazardous or non-hazardous area and are transferred bi-directionally. The device provides a sink mode or a source mode output on the safe area terminals. The device has an internal resistor. Use this resistor if the HART communication resistance in the control circuit is too low. Test sockets for the connection of HART communicators are integrated into the terminals of the device.

### Connection

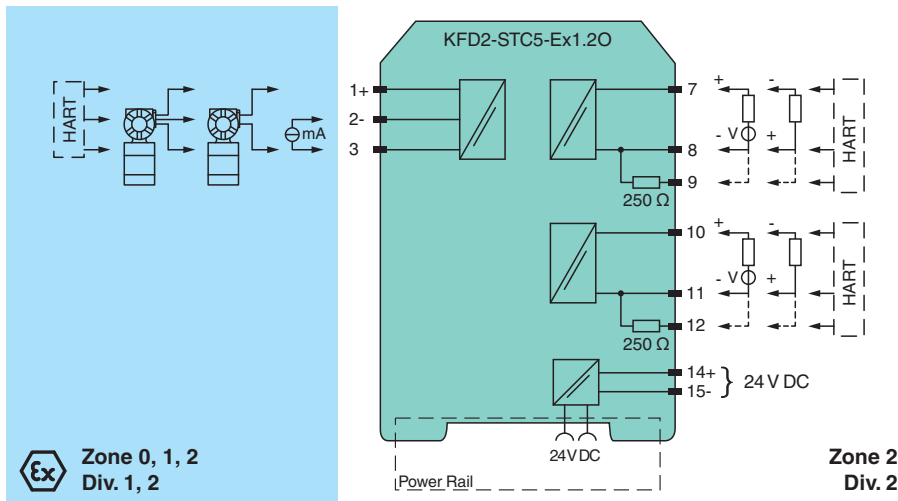

### Technical Data

General specifications	
Signal type	Analog input
Functional safety related parameters	
Safety Integrity Level (SIL)	SIL 3
Systematic capability (SC)	SC 3
Supply	
Connection	Power Rail or terminals 14+, 15-
Rated voltage	$U_r$ 18 ... 30 V DC
Ripple	within the supply tolerance
Power dissipation	≤ 1 W at maximum load

Release date: 2021-04-23 Date of issue: 2021-04-23 Filename: 239214\_eng.pdf

Refer to "General Notes Relating to Pepperl+Fuchs Product Information".

Pepperl+Fuchs Group  
www.pepperl-fuchs.com

USA: +1 330 486 0002  
pa-info@us.pepperl-fuchs.com

Germany: +49 621 776 2222  
pa-info@de.pepperl-fuchs.com

Singapore: +65 6779 9091  
pa-info@sg.pepperl-fuchs.com

**PEPPERL+FUCHS**

## Technical Data

Power consumption	≤ 1.7 W at maximum load
<b>Input</b>	
Connection side	field side
Connection	terminals 1+, 2-, 3
Input signal	0/4 ... 20 mA
Open circuit voltage/short-circuit current	terminals 1+, 3: 23 V / 25 mA
Input resistance	max. 265 Ω terminals 2-, 3 , max. 330 Ω terminals 1+, 3
Available voltage	≥ 16 V at 20 mA ; ≥ 20 V at 4 mA , terminals 1+, 3
<b>Output</b>	
Connection side	control side
Connection	terminals 7+, 8-, 9-; 10+, 11-, 12- (sink) terminals 7-, 8+, 9+; 10-, 11+, 12+ (source) see additional information
Load	0 ... 600 Ω
Output signal	0/4 ... 20 mA (overload > 25 mA)
Ripple	max. 50 μA <sub>rms</sub>
External supply (loop)	2 ... 30 V DC
<b>Transfer characteristics</b>	
Deviation	at 20 °C (68 °F), 0/4 ... 20 mA ≤ 10 μA incl. calibration, linearity, hysteresis, loads and fluctuations of supply voltage
Influence of ambient temperature	≤ 0.25 μA/K
Frequency range	field side into the control side: bandwidth with 0.5 V <sub>pp</sub> signal 0 ... 7.5 kHz (-3 dB) control side into the field side: bandwidth with 0.5 V <sub>pp</sub> signal 0.3 ... 7.5 kHz (-3 dB)
Settling time	200 μs
Rise time/fall time	100 μs
<b>Galvanic isolation</b>	
Output/power supply	functional insulation, rated insulation voltage 50 V AC
Output/Output	functional insulation, rated insulation voltage 50 V AC
<b>Indicators/settings</b>	
Display elements	LED
Labeling	space for labeling at the front
<b>Directive conformity</b>	
Electromagnetic compatibility	
Directive 2014/30/EU	EN 61326-1:2013 (industrial locations)
<b>Conformity</b>	
Electromagnetic compatibility	NE 21:2012 EN 61326-3-2:2008
Degree of protection	IEC 60529:2001
Protection against electrical shock	UL 61010-1:2012
<b>Ambient conditions</b>	
Ambient temperature	-20 ... 60 °C (-4 ... 140 °F) extended ambient temperature range up to 70 °C (158 °F), refer to manual for necessary mounting conditions
<b>Mechanical specifications</b>	
Degree of protection	IP20
Connection	screw terminals
Mass	approx. 200 g
Dimensions	20 x 124 x 115 mm (0.8 x 4.9 x 4.5 inch) , housing type B2
Mounting	on 35 mm DIN mounting rail acc. to EN 60715:2001
<b>Data for application in connection with hazardous areas</b>	
EU-type examination certificate	CML 17 ATEX 2031X
Marking	Ⓜ II (1)G [Ex ia Ga] IIC Ⓜ II (1)D [Ex ia Da] IIIC Ⓜ I (M1) [Ex ia Ma] I
Input	[Ex ia Ga] IIC, [Ex ia Da] IIIC, [Ex ia Ma] I
Supply	

Release date: 2021-04-23 Date of issue: 2021-04-23 Filename: 239214\_eng.pdf

## Technical Data





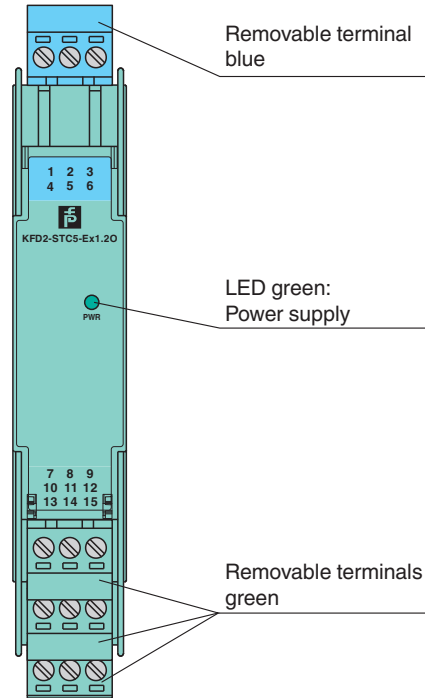

Maximum safe voltage	$U_m$	250 V (Attention! The rated voltage can be lower.)
Equipment		terminals 1+, 3-
Voltage $U_o$		26.2 V
Voltage $U_q$		27.25 V
Current $I_o$		93 mA
Power $P_o$		634 mW
Equipment		terminals 2-, 3
Voltage $U_i$		30 V
Current $I_i$		115 mA
Power $P_i$		max 1 W
Voltage $U_o$		2 V
Current $I_o$		8.5 mA
Power $P_o$		4.3 mW
Equipment		terminals 1+, 2 / 3-
Voltage $U_o$		26.2 V
Voltage $U_q$		27.25 V
Current $I_o$		115 mA
Power $P_o$		784 mW
Certificate		CML 17 ATEX 3030X
Marking		Ⓜ II 3G Ex ec IIC T4 Gc
Galvanic isolation		
Input/Output		safe electrical isolation acc. to IEC/EN 60079-11:2007, voltage peak value 375 V
Input/power supply		safe electrical isolation acc. to IEC/EN 60079-11:2007, voltage peak value 375 V
Directive conformity		
Directive 2014/34/EU		EN IEC 60079-0:2018+AC:2020 , EN 60079-11:2012 , EN IEC 60079-7:2015+A1:2018
<b>International approvals</b>		
UL approval		
Control drawing		116-0439 (cULus)
IECEX approval		
IECEX certificate		IECEX CML 17.0016X
IECEX marking		[Ex ia Ga] IIC , [Ex ia Da] IIIC , [Ex ia Ma] I Ex ec IIC T4 Gc
<b>General information</b>		
Supplementary information		Observe the certificates, declarations of conformity, instruction manuals, and manuals where applicable. For information see <a href="http://www.pepperl-fuchs.com">www.pepperl-fuchs.com</a> .

**Assembly**





Front view



**Matching System Components**

	<b>KFD2-EB2</b>	Power Feed Module
	<b>UPR-03</b>	Universal Power Rail with end caps and cover, 3 conductors, length: 2 m
	<b>UPR-03-M</b>	Universal Power Rail with end caps and cover, 3 conductors, length: 1,6 m
	<b>UPR-03-S</b>	Universal Power Rail with end caps and cover, 3 conductors, length: 0.8 m
	<b>K-DUCT-BU</b>	Profile rail, wiring comb field side, blue
	<b>K-DUCT-BU-UPR-03</b>	Profile rail with UPR-03- * insert, 3 conductors, wiring comb field side, blue

**Accessories**

	<b>KF-ST-5GN</b>	Terminal block for KF modules, 3-pin screw terminal, green
	<b>KF-STP-5GN</b>	Terminal block for KF modules, 3-pin screw terminal, with test sockets, green
	<b>KF-STP-5BU</b>	Terminal block for KF modules, 3-pin screw terminal, with test sockets, blue
	<b>KF-CP</b>	Red coding pins, packaging unit: 20 x 6

Release date: 2021-04-23 Date of issue: 2021-04-23 Filename: 239214\_eng.pdf

Refer to "General Notes Relating to Pepperl+Fuchs Product Information".

## Application

The device supports the following SMART protocols:

- HART
- BRAIN
- Foxboro

## Connection

The device provides 2 outputs on the control side terminals. These outputs can be operated in any combination of the current sink operating mode and current source operating mode. Please refer to the following diagram for connection.

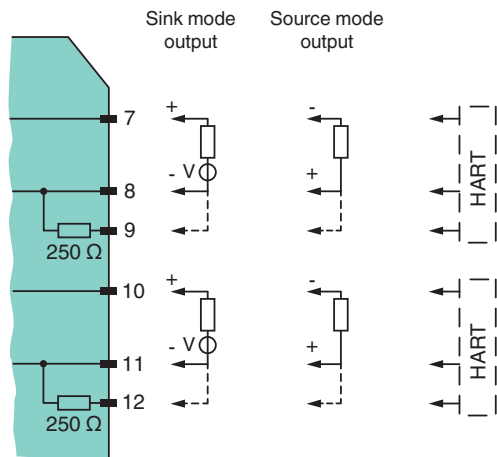

## Connection

Short circuit unused outputs decreases the internal power dissipation by up to 100 mW per channel.